

MIT S ALLOY

EXPLORE WITH NO LIMITS

PACKAGE FITTING PROCEDURE

MAZDA BT-50 DUAL CAB

2020 TO CURRENT



MIT S ALLOY

EXPLORE WITH NO LIMITS

CONTENTS

VEHICLE SPECIFIC HARDWARE CHECKLIST	3 - 4
FITTING TRAY MOUNTS	5 - 6
WIRING PREPARATION	7 - 8
LIFTING THE TRAY AND CANOPY	9
LINING UP AND BOLTING THE TRAY	10 - 13
DRILLING THE SENSORS	14
FUEL FITMENT	15
WIRING	16
CROSSLANE / BLIND SPOT MONITORING	17 - 19
GUARDS AND BOXES	20 - 22
60L WATER TANK ASSEMBLY	23
CLEANING AND FINAL CHECKS	24

VEHICLE SPECIFIC HARDWARE

CHECKLIST

MAZDA BT-50 DUAL CAB – 2020 TO CURRENT

QTY	DESCRIPTION	PART NO°	CHECKED OFF
TRAY SPECIFICICATIONS			
1	TRAY – 850 X 1765L X 1870W		
N/A	FRONT BOX		
2	REAR BOX – 900L X 180W		
2	GUARDS – 35" GUSSETED FRONT / INTERNAL		
1	PASSENGER FRONT – BROWN DAVIS		
MOUNTS			
2	F - F		
4	F - R		
1	UNIVERSAL MOUNTING KIT		
2	MUDFLAPS + HARDWARE		
FUEL HARDWARE			
1	UNIVERSAL HEADBOARD FUEL FILLER BRACKET		
1	BROWN AND DAVIS FUEL FILLER NECK + DIESEL CAP		
1	13mm TO 25mm HOSE CLAMPS		
2	M6 x 20mm SS BUTTONHEADS		
2	M6 SS SPRING WASHERS		
2	M6 SS FLAT WASHERS		
FLUX 3D CAMERA RELOCATION - IF REQUESTED ON THE INVOICE			
1	PLASTIC CAMERA BRACKET	CB003	
2	M6 x 20mm SS BUTTON HEAD BOLTS		
2	M6 SS FLAT WASHERS		
2	M6 SS NYLOC NUTS		
FLUX 3D REVERSE SENSOR RELOCATION - IF REQUESTED ON THE INVOICE			
1	FLUX REVERSE SENSOR BRACKET KIT	SB025	
4	REVERSE SENSOR EXTENSION HARNESSSES – 1M	WH025	
FLUX 3D CROSSLANE RELOCATION - IF REQUESTED ON THE INVOICE			
1	FLUX PLASTIC HOUSING KIT	BSB045CC	
1 SET	ALLOY CROSSLANE BRACKETS		
16	M6 x 20mm SS BUTTON HEAD BOLTS		
16	M6 SS FLAT WASHERS		
8	M6 SS SPRING WASHERS		
8	M6 SS SPRING WASHERS		
8	M6 NYLON WASHERS		
8	M6 SS NYLOC NUTS		

VEHICLE SPECIFIC HARDWARE

CHECKLIST

MAZDA BT-50 DUAL CAB - 2020 TO CURRENT

ELECTRICAL

1 SET	ISUZU DMAX PATCH HARNESS KIT		
9	STICKY BACK CABLE TIE HOLDERS		
PARTY PACK AND DOCUMENTATION			
1	HAT, STUBBY COOLER, BOTTLE OPENER		

FITMENT PROCEDURES

FITTING THE TRAY MOUNTS

Using the mounts provided in the kit, fit each mount to the existing tub mounts on the vehicle.
Reference the letter indicator on each mount to ensure proper fitment location:

- ❖ F = FRONT.
- ❖ M1 = MIDDLE CLOSEST TO FRONT.
- ❖ M2 = MIDDLE CLOSEST TO REAR.
- ❖ R = REAR.

When fitting mounts without a captive nut on the vehicle, use the following hardware:

- ❖ 1 x - M12 x 40mm Course Thread ZN Hex Bolt.
- ❖ 2 x - M12 ZN Hardened Washer.
- ❖ 2 x - ½ x 2 x 16G ZN Panel Washers.
- ❖ 1 x - M12 ZN Nyloc Nut.

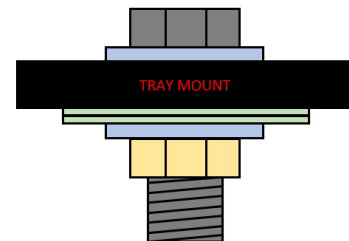

When fitting mounts with a captive nut on the vehicle, use the following hardware:

- ❖ 1 x - M12 x 40mm Fine Thread ZN Hex Bolt.
- ❖ 1 x - M12 ZN Spring Washer.
- ❖ 1 x - M12 ZN Hardened Washer.

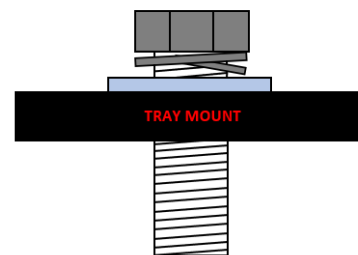

All the relevant hardware should be provided inside the kit.

FITTING THE TRAY MOUNTS

Tighten each mount till they are only just a little more than finger tight. Once done, you can hit each mount towards the outsides of the car to ensure you have a minimum gap of 1040mm between each mount.

For the BT 50 the mounts required are as follows:

F - F for the front mounts (x 2)

F - R for the middle and rear mounts (x 4)



WIRING PREPERATION

Take the time while the tray is off to cable tie and tidy up any loose wiring along the chassis rail. This includes securing the fuel cap cable from the tub, the lighting harness, camera harness and any wiring that may be fitted to the vehicle.

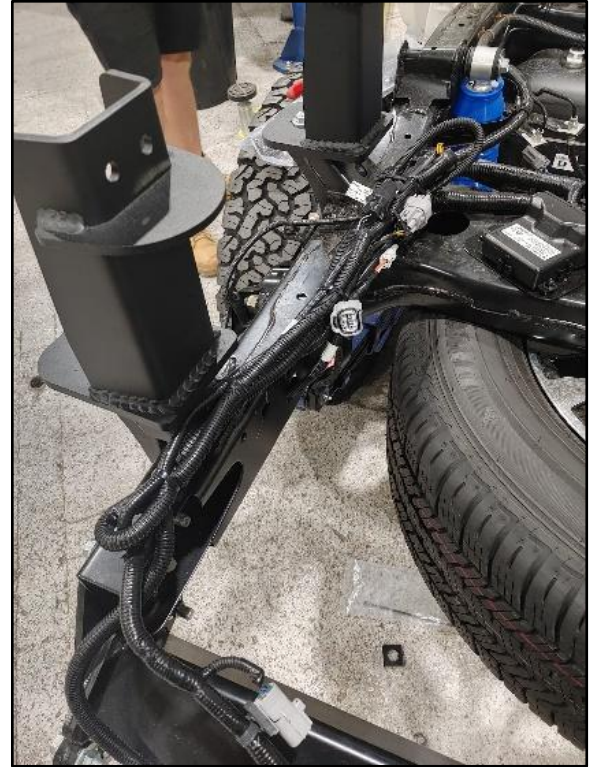

HARNESS EXTENSIONS

Extend all 4 reverse sensors with the supplied harnesses by joining 2 together to achieve the required length. Then manually extend the 2 blind spot sensors 900mm. This allows you to run and tuck the harness behind the rear cross member, keeping it nice and neat. You will have enough length to run each of the reverse sensors up the rear mounts of either side and along the wings on the rear of the tray. There is a cable management channel integrated into the tray wings to allow you to run the reverse sensors neatly once the tray is fitted to the vehicle.

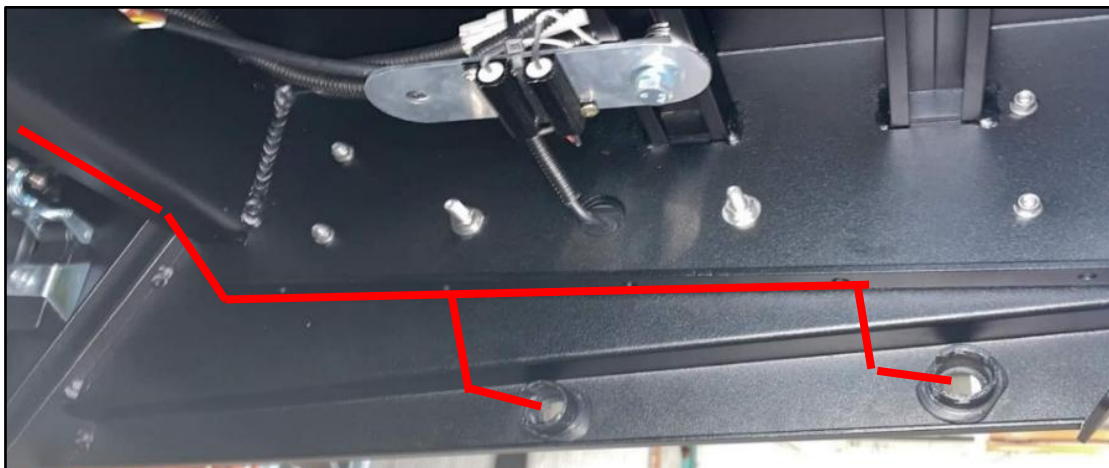



LIFTING THE TRAY AND CANOPY

When lifting the tray and canopy onto a vehicle, the ideal way to lift is using a jib crane, rated slings and steel poles in each of the lifting points on the canopy. This allows you to have maximum manoeuvrability. Ensure when using slings, you have blankets or foam to cover the doors as the slings may damage them.

The other option if there is no forklift jib available is to set the package up in the hoist with the arms under each corner of the package, this allows you to reverse the car under carefully and then lower the package onto the back of the car.

When undergoing either process, we recommend using a spotter to both watch and help guide the package onto the mounts safely.



LINING UP AND BOLTING THE TRAY

NORTH SOUTH MEASUREMENT

When lining up the tray, first do a visual check and make sure the tray isn't twisted on the mounts. If so, straighten the tray and ensure all the mounts are sitting evenly on either side of tray chassis rails.

Once everything is visually lined up, take your first measurement between the headboard cross brace and the back window, and needs to be **65mm** as depicted in the reference photo below.

You can also measure between the headboard mesh upright and back window as it is a sharp line to measure off, this just means you add 20mm to the first measurement for a total of **85mm**.

Measure between the tray and cab on both the driver's side and passenger side, ensuring you measure the same reference point and get the same measurements each side.

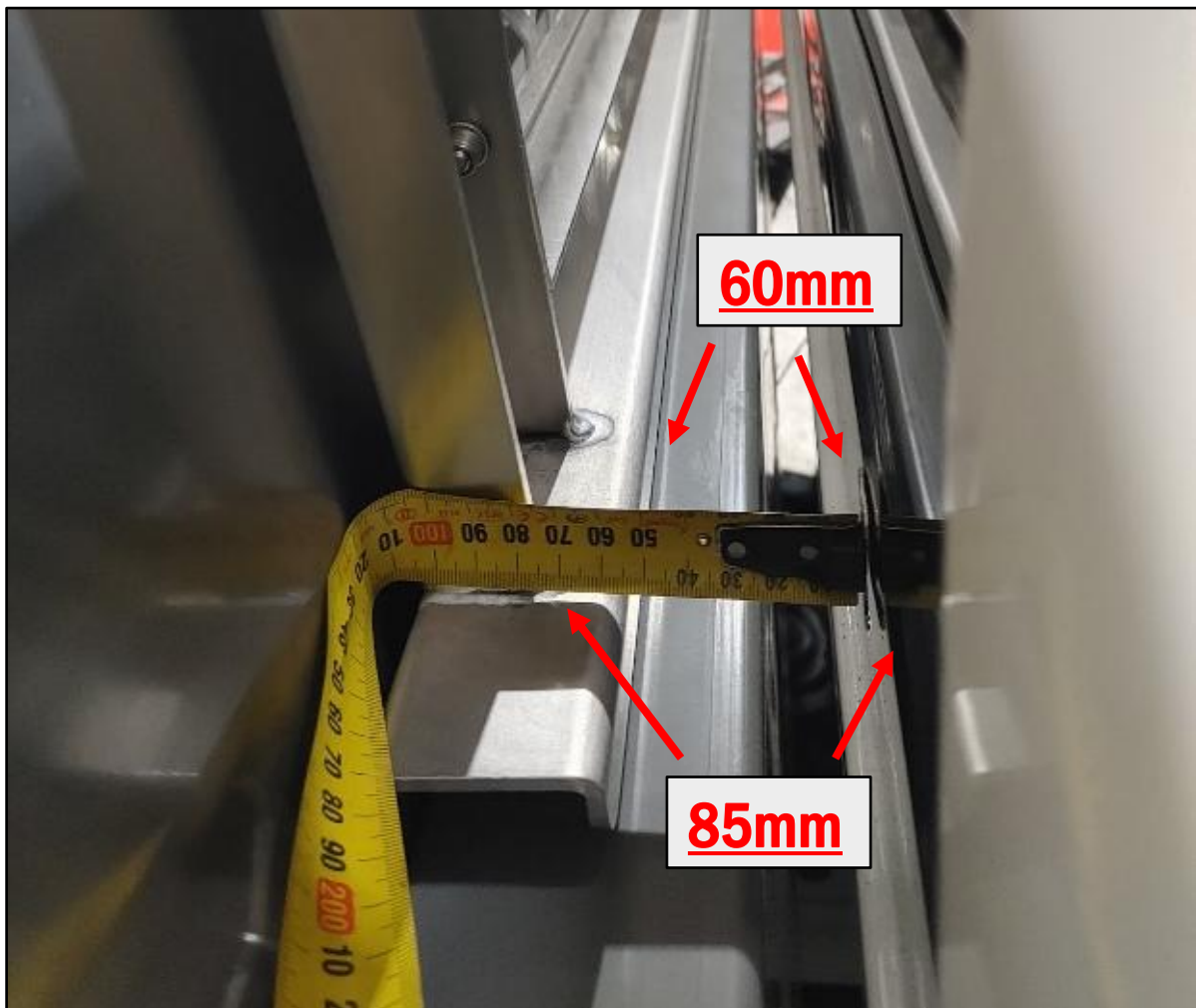

LINING UP AND BOLTING THE TRAY

EAST WEST MEASUREMENT



When measuring the east west (side to side) you need a straight edge to hold against the outside of the headboard so you can measure between the straight edge and the chassis rail as shown in the reference photos below.

Before placing a straight edge against the headboard, protect the surface from scratches by running a line of masking tape up the headboard on either side of the tray.

When measuring, pick the same corresponding point on either side of the vehicle's chassis, this allows you to be as accurate as possible when measuring. You are aiming to have the measurements on either side of the tray to be as close as possible to each other.

When making small adjustments side to side, you might find you have more control by hitting the mount in using a soft blow mallet towards the direction you need to go vs pulling or pushing on the tray by hand.

Once you are happy with the measurements, hit one mount in flush with the tray, tighten it up to 77nm then proceed to hit the opposite mount in flush with the tray and tighten it up to 77nm. Also recheck both north - south measurements to ensure the tray hasn't shifted forward.

Measure and bolt the front mounts before moving onto the middle and rear mounts.



LINING UP AND BOLTING THE TRAY

EAST WEST MEASUREMENT

Double check you north south measurements, then bolt the front mounts to tray referring to BOLTING THE MOUNTS TO TRAY section on page 10. Measure east west of the rear of the tray, this time using the straight edge on the tray chassis rail and measuring to the rear tow bar either side or vehicle chassis rail as per the reference photo.



Again, once the measurements side to side are the same, hit the middle and rear mount in flush with the tray chassis, tighten to 77nm and bolt the mounts to the tray referencing the BOLTING THE MOUNTS TO TRAY section on page 10 of this procedure.

LINING UP AND BOLTING THE TRAY

BOLTING THE MOUNTS TO TRAY

Drill and bolt your front mounts first once they are lined up and tight. Use a 10mm drill bit to drill through the predrilled holes on the mounts into the tray chassis. Bolt each one using the following hardware:

- ❖ 1 x - M10 X 30mm ZN hex bolt
- ❖ 2 x - M10 hardened ZN washers.
- ❖ 1 x - M10 ZN nylon nut
- ❖ High Strength Threadlocker

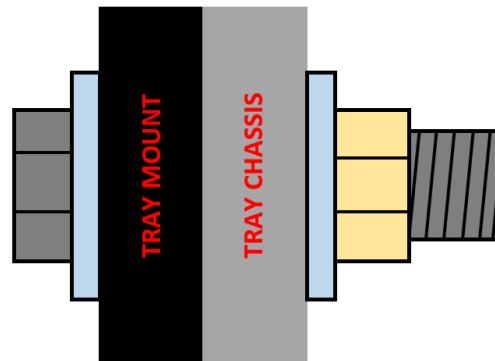

Tighten each bolt up to 44nm. Repeat this process on the middle and rear mounts once those mounts have been set and tensioned.

Once every M10 bolt is tensioned, go around and witness mark each one. This is both a check for the person tightening the bolts, as well as visual check for someone else checking them. You can either use a paint pen or use a torque marking pen.



DRILLING THE REVERSE SENSORS

When marking out for your sensors, start out by taping up each side of your wings where you'll be marking and drilling. This allows you to mark freely on the face, as well as helps protect the face from scratching once you start drilling.

The first hole will be 40mm in from the outside edge of the tray and needs to be situated in the middle face.

The second hole will be 175mm from the first hole and in the middle of the face as well.

Take as much time as you can getting your marks as close as you possible to the middle, within 1mm. Once marked, centre punch your holes and then pilot drill it with a 5mm drill bit.

Using a step drill, open the holes up to 32mm.

We recommend using WD40 or a cutting fluid on the drill bit. Debur your holes and fit your 3D sensor housings.

Mirror this process to the opposite side of the tray.

Finish each of the hole by deburring them with a handheld deburring tool.

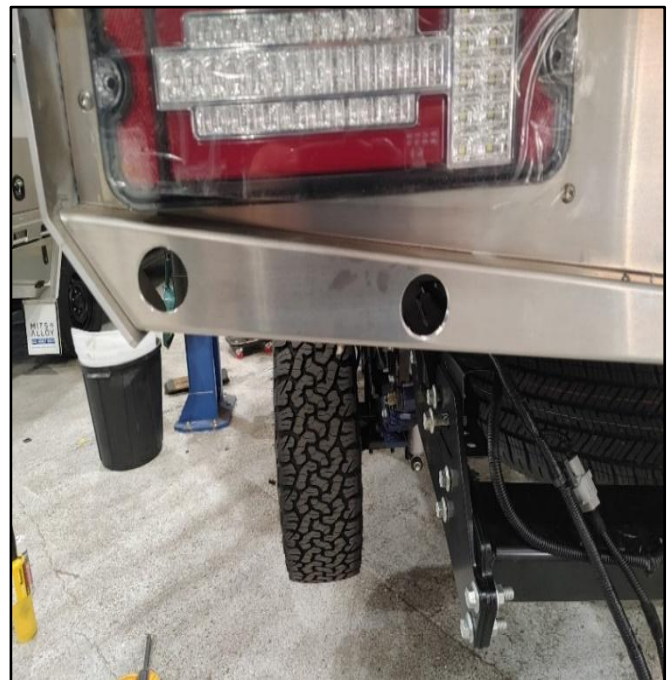

Fit the SB025 reverse sensor relocation brackets into the 32mm holes in the wings. When tensioning the brackets, take into consideration how the reverse sensor wiring will sit on the back of the wings so that the wiring is both neat but also won't rub against any surfaces.

FUEL FITMENT

If the vehicle being fitted is a tub version, you will be able to retain the factory filler hose and breather as they have sufficient length to reach the aftermarket filler position on the tray. In this case you can use the factory clamps and may need to cut about 10 - 15mm out of the filler hose to prevent any kinks.

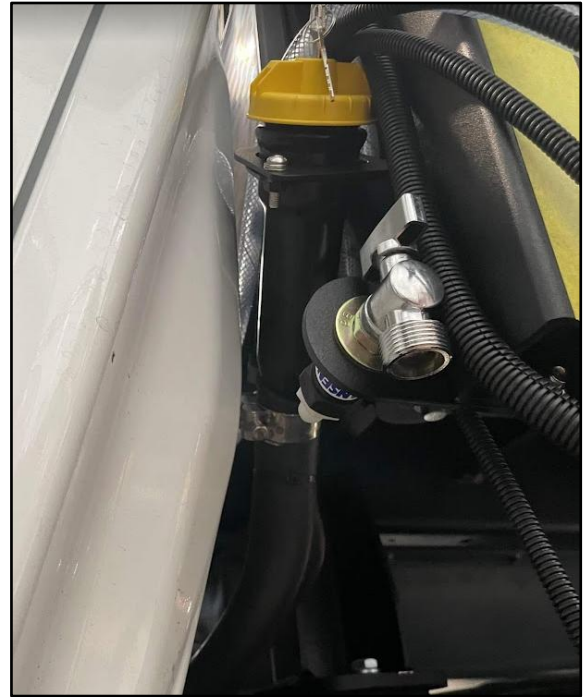

A

WIRING

Now that the tray has been fitted to the vehicle and the extended harness has been run along the back of the vehicles rear crossmember, continue the harness up the rear mounts and along the tray to each of the tray wings. Make sure you use the holes along the tray chassis rail and on the back of the wings to cable tie the harness along to keep it as neat as possible.

Plug in the DMAX / BT-50 lighting patch harness and run it up to the female 6 pin Deutsch plug that comes from the resistor pack on the tray. Secure it alongside the reverse harness along the tray mounts and chassis rail.

This is also the perfect time to plug in your reverse camera. You will be able to apply a small amount of superglue and place 5 sticky backs along the backside of the camera bracket and up the side of the rear pull out drawer to allow you to neatly secure the camera cabling. Once cable tied up you will be able to run the rest of the cable down the back of the mount with the rest of the wiring.



CROSSLANE / BLIND SPOT MONITOR

MOUNTING THE CROSSLANE ALLOY BRACKETS

When fitting the alloy bracket to the back of the rear undertray boxes, start by taping where you're going to mark, this allows you to not only see your marks easier but also prevents the boxes from being scratched.

Mark the crosslane bracket holes as per the diagram by using the crosslane bracket as a template.

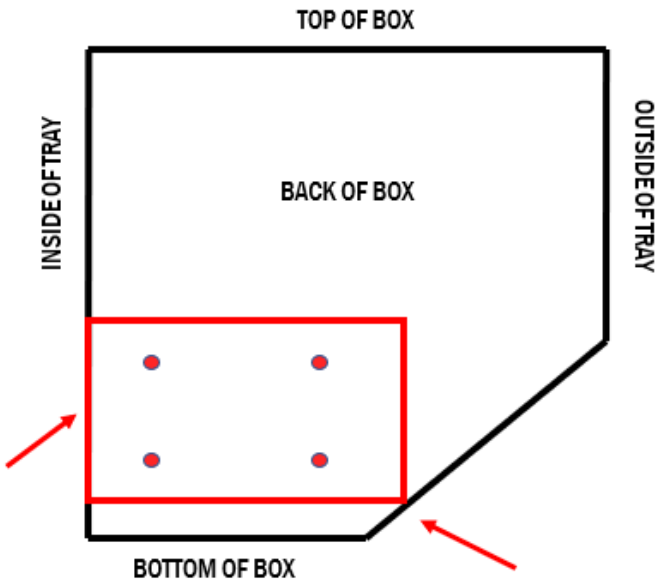

LINE UP THE BACK OF THE BRACKET SO IT SITS FLUSH WITH THE INSIDE EDGE OF THE BOX

BRING THE BRACKET DOWN UNTIL THE CORNER LINES UP WITH THE EDGE OF THE BOX HERE

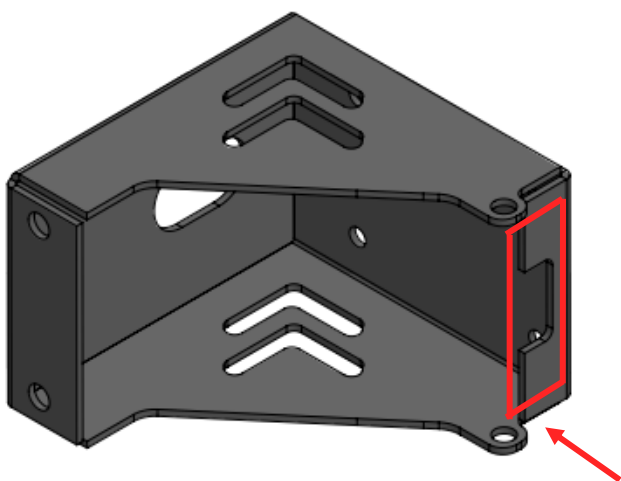

ISOMETRIC VIEW

THIS FACE TOWARDS THE OUTSIDE OF THE TRAY



CROSSLANE / BLIND SPOT MONITOR

Once you have the holes marked out, centre punch each hole and drill them out to 6mm. Fit the bracket using the following hardware:

- ❖ 4 x - M6 x 20mm SS button head bolts
- ❖ 8 x - SS flat washers
- ❖ 4 x - nylon washers
- ❖ 4 x - SS nylon nuts

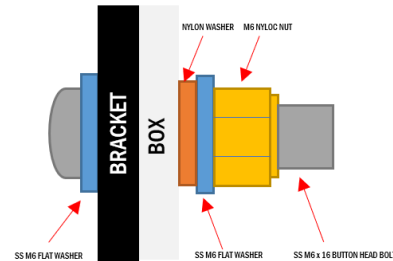

FITTING THE CROSSLANE

Once the alloy crosslane brackets have been bolted to the back of both boxes, continue by plugging the crosslane sensors into the crosslane harness and fit the plastic housings into the alloy bracket using the bolts supplied in the plastic housing kit. Make sure you're fitting the LH and RH sensor in the correct position. With the BSB045CC plastics, it's easier to remove the right-angle plastic cover on each of the crosslane plugs and replace with harness tape, this allows you to get more flexibility out of the harness to allow you to fit the plastic housing into the alloy bracket. Finish off the crosslane assembly by cable tying the rest of the harness along the back of the under tray boxes so it's tucked out of the way and looks neat.

TESTING THE CROSSLANES FUNCTION

Once the crosslane assembly is fitted to the car, take the car on a road test to confirm their function. Ideally the crosslane system will start functioning straight away by sensing other vehicles coming in and out of its blind spot on each side of the car. The sensors shouldn't pick up barriers or trees.

If the crosslane system isn't functioning as per the factory function, then the system may need to be calibrated. This can be achieved by taking the vehicle for a drive along a road that contains solid concrete barriers. You'll need to drive next to these barriers on both the RH and LH side of the car for a couple hundred metres. This will allow the crosslane system to use them as a reference point to calibrate its system.

If you're still having no luck and issues after installation, check over all your wiring extensions to ensure you haven't made any mistakes. If the wiring is all correct, then refer to your local dealership to have the sensors tested for errors.

GUARDS AND BOXES



When setting your first guard on the tray in relation to the wheel, ensure you set it while the car is off the hoist at rest, or at the height the car will be sitting when aftermarket suspension is fitted.

As the suspension travels up and down, the axle moves back and forth. By doing this, you are ensuring the guard is sitting as centre as possible when the car is at rest.

Once you are happy with the location of the first guard, fit it to the underside of the tray using:

- ❖ 4 x M10 spring nuts
- ❖ 4 x M10 x 25mm zinc bolts
- ❖ 4 x M10 zinc spring washers
- ❖ 4 x 3/8 x 1 1/2 x 16G zinc washers.

Mirror this on the other side of the tray with the other guard. Use a measuring tape to ensure both guards set at the same point.

Before all the bolts are tightened up, ensure the guard is centre on the wheels and hard up against the rope rails.



GUARDS AND BOXES



Once the guards are fitted and the bolts tensioned, set the toolbox in place on the back of the guard and mark the bolt locations on the Unistrut with a paint pen.

Remove the toolbox and fit the 4 x M10 spring nuts at each of the paint pen marks on the Unistrut.

Fit the toolbox into place using the:

- ❖ 4 x M10 x 25mm Zinc Bolts
- ❖ 4 x M10 Zinc Spring Washers
- ❖ 4 x 3/8 x 1 x 16G Zinc Washers.

Keep the bolts finger tight and push the toolbox hard against the back of the guard.

Adjust the toolbox side to side so that the forward seam on the toolbox lines up with the first fold on the outside edge of the guard.



Once you're happy with the toolbox adjustment, tension all the bolts and repeat this process on the other side of the car.

When setting the box in relation to the tray, ensure the door sits just in from the edge or rope rail as well as set parallel to the rope rail.



GUARDS AND BOXES



Once all the guards are set and tight, drill a M6 hole from the inside of the box, into the backside of the guard.

Debur your hole and then bolt the box to the guard using:

- ❖ 1 x M6 x16mm stainless steel button head bolt
- ❖ 1 x M6 nylon washer
- ❖ 1 x M6 stainless flat washer
- ❖ 1 x M6 stainless steel nylon nut.

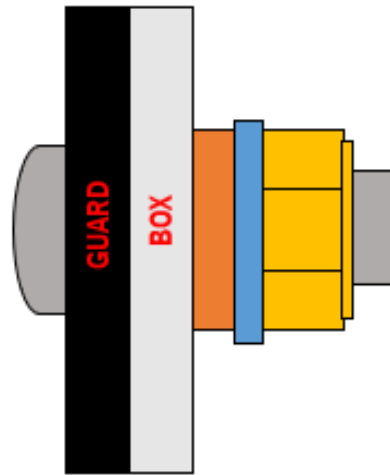

Go around and check that all the box locks are tight and adjusted so that the door pulls in hard against the box seal. This all can be done using a 10mm spanner.



60LITRE TAP ASSEMBLY

There are two tap locations depending on whether the car has blind spot monitoring or not.

BLIND SPOT MONITORS – The tap can either be a straight tap bracket, that comes down from the rear pullout drawer camera bracket. You will need to position it in a location that won't interfere with anything, then mark and drill so that you can secure it with the M6 mounting Hardware provided.

Or, if it doesn't interfere with the blind spot brackets you can mount the 90 degree tap bracket either onto the back of the alloy bracket or straight onto the box.

Either option is acceptable if the functionality and the aesthetics of the tap remain.

NO BLIND SPOT MONITORING – The tap bracket being used is a 90° bracket that gets positioned at the bottom back edge of the passenger side under tray toolbox. The customer can opt to have it on the driver's side if they want, but the universal spot is on the passenger side. Mark the location, drill and mount using the M6 mounting hardware provided.

When running the hose and power for the switch to the tap at the rear of the tray, ensure the cable management holes in the chassis are used. Neatly tuck and mount the cable and hose inside the channel using either cable ties or small P clamps.

Keep in mind that depending on factors like aftermarket rear bars or tow bars, the tap location may need to change to accommodate these features.

Tap being mounted on the camera bracket where the cross-traffic bracket is mounted on the box.



Tap mounted on back of box in bottom corner. Still ensuring it clears the cross-traffic sensor.

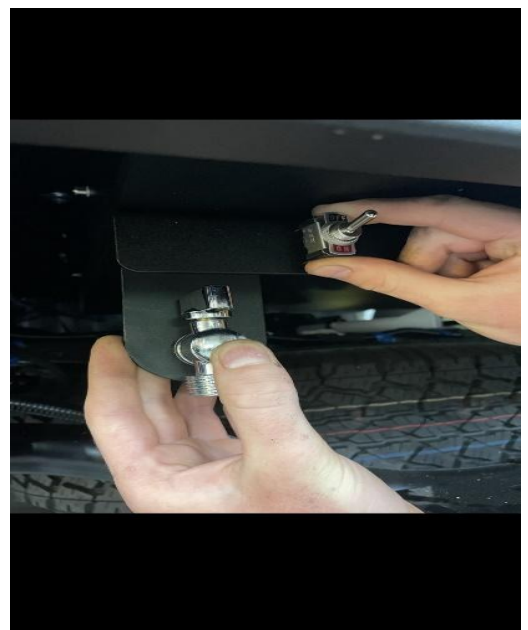

CLEANING AND FINAL CHECKS

When cleaning the tray and canopy, take into consideration whether its milled, 2 Pac or powder coated.

- ❖ For milled / raw alloy surfaces, we clean any fold lines off with thinners and then clean the tray with WD40 and a microfibre rag, when cleaning milled, ensure your wiping with the grain on the alloy to minimise the risk of scratching. Small scratches can be taken out with purple polish but will start to shine the alloy if you're not careful.
- ❖ For Powder coated surfaces, we use either Windex / window cleaner or quick detailer like Bowden's Boss Gloss, along with a microfibre cloth.
- ❖ For painted surfaces, we use a quick detailer such as Bowden's Boss Gloss, as it has a lubricant in it to prevent swirl marks and scratches.

While cleaning, take the time to look over the product and make sure there's no defects, things missing, or loose. Finish your clean by collecting all your keys from the toolboxes and the rear pull out drawer and putting them with the party pack in the cab. Make sure to run through the invoice to ensure everything is supplied and correct.